

TYPE		ITEM CODE	PRICE IN CHF
TSE-11	Clockwise and anti-clockwise triggering 5 - 55 mNm	01-0002-011	
TSE-21	Clockwise triggering and anti-clockwise blocking 5 - 55 mNm	01-0002-021	
TSE-31	Anti-clockwise triggering and clockwise blocking 5 - 55 mNm	01-0002-031	
TSE-41	Clockwise and anti-clockwise triggering 20 - 80 mNm	01-0002-41	
TSE-51	Clockwise triggering and anti-clockwise blocking 20 - 80 mNm	01-0002-51	
TSE-121	Clockwise triggering and anti-clockwise blocking 20 - 120 mNm	01-0002-121	



TSE-11 to 51













TSE-121



Torque screwdriver types TSE-11 to 51ACR are supplied without ACR adapter, ACR reduction sleeve and STD identification ring (standard), which must be ordered separately. For TSE-121, a black ring is supplied.



All screwdrivers (1) are supplied in a box (2) with a torque adjustment wrench (3) and the STD screwdriver bit locking screw!

SUPPLIES TO BE ORDERED SEPARATELY	ITEM CODE		PRICE IN CHF
Quick-change adapter $\varnothing 0.5$ to $\varnothing 3.00$ (TSE-11 to 51 + TSE-121)	10-0008-XXX		
ACR identification ring TSE-11 to 51	10-0005-XX		
ACR identification ring TSE121	10-0005-1XX		
ACR reduction sleeve TSE-11 to 51	10-0007-XXX		
STD reduction sleeve TSE-121	10-0006-XXX		
STD identification ring TSE-11 to 51	10-0004-XXX		
Identification ring 11mm TSE-1X1	10-0004-XXX		
STD screwdriver bits $\varnothing 0.5$ à $\varnothing 3.00$	10-0001-XXX		

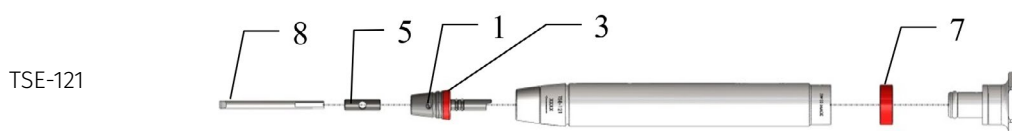
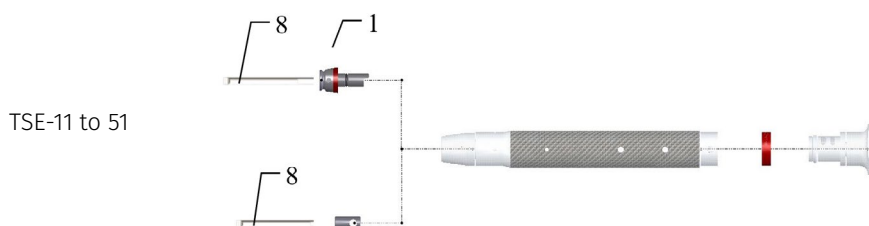

AFTER-SALES SUPPLIES	ITEM CODE	PRICE IN CHF
ACR wick locking screw TSE-11 to 51	10-0016-001	
ACR wick locking screw TSE-1X1	10-0016-006	
O-Ring ACR TSE-11 to 51	10-0013-001	
ACR O-Ring TSE-1X1	10-0013-004	
STD wick locking screw	10-0016-002	
Turret screws TSE-10 to 51	10-0016-004	
Turret screw TSE-1X1	10-0016-005	
Turret	10-0015-XXX	

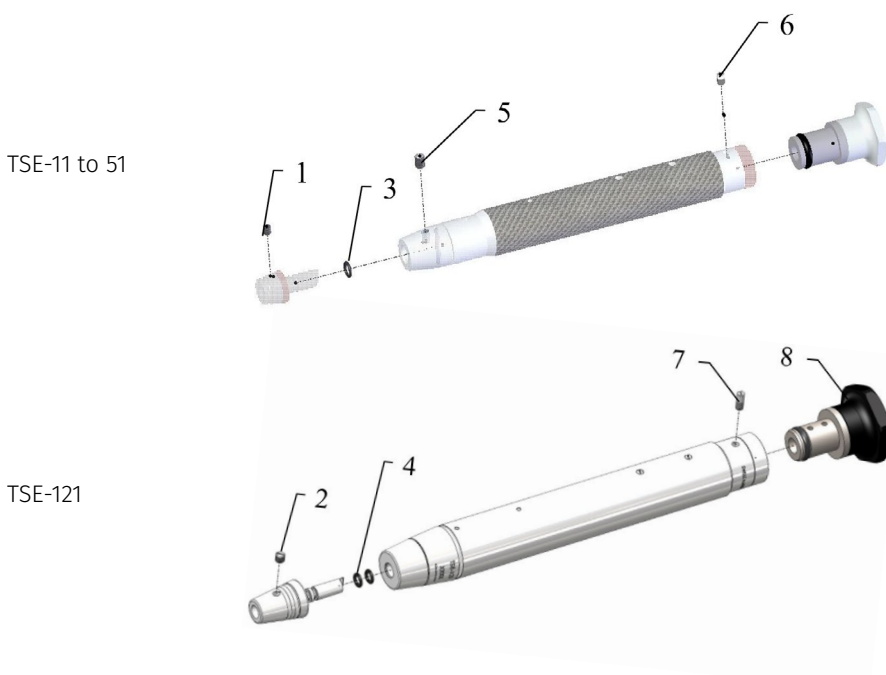

TYPE		ITEM CODE	PRICE IN CHF
TSE-11	Clockwise and anti-clockwise triggering 5 - 55 mNm	01-0002-011	401.40
TSE-21	Clockwise triggering and anti-clockwise blocking 5 - 55 mNm	01-0002-021	438.00
TSE-31	Anti-clockwise triggering and clockwise blocking 5 - 55 mNm	01-0002-031	438.00
TSE-41	Clockwise and anti-clockwise triggering 20 - 80 mNm	01-0002-031	462.00
TSE-51	Clockwise triggering and anti-clockwise blocking 20 - 80 mNm	01-0002-051	484.00
TSE-121	Clockwise triggering and anti-clockwise blocking 20 - 120 mNm	01-0002-0121	608.00

01-0002-011



01-0002-041/51



01-0002-021



01-0002-0121



01-0002-031



**QUANTITY DISCOUNT**

0 to 9 parts	net	20 to 49 parts	8%
10 to 19 parts	5%	50 parts and more	10%

ITEM CODE		DIAMETER	PRICE IN CHF
10-0008-005	Quick-change adapter	∅ 0.50	13.70
10-0008-006	Quick-change adapter	∅ 0.60	13.70
10-0008-007	Quick-change adapter	∅ 0.70	13.70
10-0008-008	Quick-change adapter	∅ 0.80	13.70
10-0008-009	Quick-change adapter	∅ 0.90	13.70
10-0008-010	Quick-change adapter	∅ 1.00	13.70
10-0008-011	Quick-change adapter	∅ 1.10	13.70
10-0008-012	Quick-change adapter	∅ 1.20	13.70
10-0008-013	Quick-change adapter	∅ 1.30	13.70
10-0008-014	Quick-change adapter	∅ 1.40	13.70
10-0008-015	Quick-change adapter	∅ 1.50	13.70
10-0008-016	Quick-change adapter	∅ 1.60	13.70
10-0008-018	Quick-change adapter	∅ 1.80	13.70
10-0008-020	Quick-change adapter	∅ 2.00	13.70
10-0008-025	Quick-change adapter	∅ 2.50	19.90
10-0008-030	Quick-change adapter	∅ 3.00	19.90
10-0008-000	Complet set of quick-change adapters	∅ 0.5 to 2.00	173.40
10-0008-121	Quick-change adapter TSE121	∅ 3.00	19.90

**QUANTITY DISCOUNT**



0 to 9 parts	net
10 to 49 parts	5%
50 to 99 parts	8%
100 parts and more	10%

**FOR TSE-121**



**FOR TSE-11 TO 51**





















ITEM CODE		SCREWDRIVER BITS Ø		COLORS	PRICE IN CHF
10-0005-005	ACR identification ring	0.50		Light orange C1	4.00
10-0005-006	ACR identification ring	0.60		Natural elox	4.00
10-0005-007	ACR identification ring	0.70		Gold D1	4.00
10-0005-008	ACR identification ring	0.80		Yellow E3	4.00
10-0005-009	ACR identification ring	0.90		Light green K3	4.00
10-0005-010	ACR identification ring	1.00		Black J3	4.00
10-0005-011	ACR identification ring	1.10		Dark grey J2	4.00
10-0005-012	ACR identification ring	1.20		Red B3	4.00
10-0005-013	ACR identification ring	1.30		Light brown I1	4.00
10-0005-014	ACR identification ring	1.40		Light grey J1	4.00
10-0005-015	ACR identification ring	1.50		Blue F3	4.00
10-0005-016	ACR identification ring	1.60		Purple K1	4.00
10-0005-018	ACR identification ring	1.80		Dark orange C3	4.00
10-0005-020	ACR identification ring	2.00		Dark green H3	4.00
10-0005-030	ACR identification ring			Pink B1	4.00
10-0005-031	ACR identification ring			Dark blue G3	4.00
10-0005-032	ACR identification ring			Dark brown I3	4.00
10-0005-033	ACR identification ring			Light blue F1	4.00
10-0005-000	Complete set of ACR rings	0.50 to 2.00			56.00

**QUANTITY DISCOUNT**

0 to 9 parts	net	50 to 99 parts	8%
10 to 49 parts	5%	100 parts and +	10%









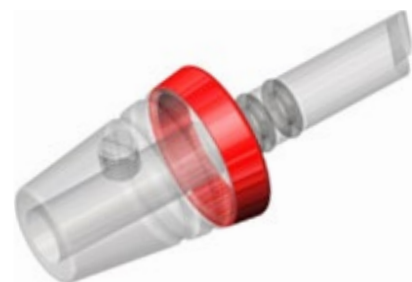











ITEM CODE		SCREWDRIVER BITS Ø		COLORS	PRICE IN CHF
10-0005-105	ACR identification ring	0.50		Light orange C1	9.50
10-0005-106	ACR identification ring	0.60		Natural elox	9.50
10-0005-107	ACR identification ring	0.70		Gold D1	9.50
10-0005-108	ACR identification ring	0.80		Yellow E3	9.50
10-0005-109	ACR identification ring	0.90		Light green K3	9.50
10-0005-110	ACR identification ring	1.00		Black J3	9.50
10-0005-111	ACR identification ring	1.10		Dark grey J2	9.50
10-0005-112	ACR identification ring	1.20		Red B3	9.50
10-0005-113	ACR identification ring	1.30		Light brown I1	9.50
10-0005-114	ACR identification ring	1.40		Light grey J1	9.50
10-0005-115	ACR identification ring	1.50		Blue F3	9.50
10-0005-116	ACR identification ring	1.60		Purple K1	9.50
10-0005-118	ACR identification ring	1.80		Dark orange C3	9.50
10-0005-120	ACR identification ring	2.00		Dark green H3	9.50
10-0005-130	ACR identification ring			Pink B1	9.50
10-0005-131	ACR identification ring			Dark blue G3	9.50
10-0005-132	ACR identification ring			Dark brown I3	9.50
10-0005-133	ACR identification ring			Light blue F1	9.50
10-0005-200	Complet set of ACR rings	0.50 to 2.00			132.00

**QUANTITY DISCOUNT**

0 to 9 parts	net	50 to 99 parts	8%
10 to 49 parts	5%	100 parts and more	10%





















ITEM CODE		SCREWDRIVER BITS Ø		COLORS	PRICE IN CHF
10-0004-005	STD 9mm identification ring	0.50		Light orange C1	4.60
10-0004-006	STD 9mm identification ring	0.60		Natural elox	4.60
10-0004-007	STD 9mm identification ring	0.70		Gold D1	4.60
10-0004-008	STD 9mm identification ring	0.80		Yellow E3	4.60
10-0004-009	STD 9mm identification ring	0.90		Light green K3	4.60
10-0004-010	STD 9mm identification ring	1.00		Black J3	4.60
10-0004-011	STD 9mm identification ring	1.10		Dark grey J2	4.60
10-0004-012	STD 9mm identification ring	1.20		Red B3	4.60
10-0004-013	STD 9mm identification ring	1.30		Light brown I1	4.60
10-0004-014	STD 9mm identification ring	1.40		Light grey J1	4.60
10-0004-015	STD 9mm identification ring	1.50		Blue F3	4.60
10-0004-016	STD 9mm identification ring	1.60		Purple K1	4.60
10-0004-018	STD 9mm identification ring	1.80		Dark orange C3	4.60
10-0004-020	STD 9mm identification ring	2.00		Dark green H3	4.60
10-0004-022	STD 9mm identification ring	2.20		Pink B1	4.60
10-0004-025	STD 9mm identification ring	2.50		Dark blue G3	4.60
10-0004-030	STD 9mm identification ring	3.00		Dark brown I3	4.60
10-0004-040	STD 9mm identification ring			Light blue F1	4.60
10-0004-000	Complete set of STD 9mm rings	0.50 to 2.00			67.50

**QUANTITY DISCOUNT**

0 to 9 parts	net	50 to 99 parts	8%
10 to 49 parts	5%	100 parts and more	10%





ITEM CODE		SCREWDRIVER BITS Ø		COLORS	PRICE IN CHF
10-0004-105	STD 11mm identification ring	0.50		Light orange C1	4.60
10-0004-106	STD 11mm identification ring	0.60		Natural elox	4.60
10-0004-107	STD 11mm identification ring	0.70		Gold D1	4.60
10-0004-108	STD 11mm identification ring	0.80		Yellow E3	4.60
10-0004-109	STD 11mm identification ring	0.90		Light green K3	4.60
10-0004-110	STD 11mm identification ring	1.00		Black J3	4.60
10-0004-111	STD 11mm identification ring	1.10		Dark grey J2	4.60
10-0004-112	STD 11mm identification ring	1.20		Red B3	4.60
10-0004-113	STD 11mm identification ring	1.30		Light brown I1	4.60
10-0004-114	STD 11mm identification ring	1.40		Light grey J1	4.60
10-0004-115	STD 11mm identification ring	1.50		Blue F3	4.60
10-0004-116	STD 11mm identification ring	1.60		Purple K1	4.60
10-0004-118	STD 11mm identification ring	1.80		Dark orange C3	4.60
10-0004-120	STD 11mm identification ring	2.00		Dark green H3	4.60
10-0004-122	STD 11mm identification ring	2.20		Pink B1	4.60
10-0004-125	STD 11mm identification ring	2.50		Dark blue G3	4.60
10-0004-130	STD 11mm identification ring	3.00		Dark brown I3	4.60
10-0004-140	STD 11mm identification ring			Light blue F1	4.60
10-0004-100	Complete set of STD 11mm rings	0.50 to 3.00			67.50

**QUANTITY DISCOUNT**

0 to 9 parts	net	50 to 99 parts	8%
10 to 49 parts	5%	100 parts and more	10%



ITEM CODE		DIAMETER	PRICE IN CHF
10-0007-005	ACR reduction sleeve	ø 0.50	16.60
10-0007-006	ACR reduction sleeve	ø 0.60	16.60
10-0007-007	ACR reduction sleeve	ø 0.70	16.60
10-0007-008	ACR reduction sleeve	ø 0.80	16.60
10-0007-009	ACR reduction sleeve	ø 0.90	8.40
10-0007-010	ACR reduction sleeve	ø 1.00	8.40
10-0007-011	ACR reduction sleeve	ø 1.10	8.40
10-0007-012	ACR reduction sleeve	ø 1.20	8.40
10-0007-013	ACR reduction sleeve	ø 1.30	8.40
10-0007-014	ACR reduction sleeve	ø 1.40	8.40
10-0007-015	ACR reduction sleeve	ø 1.50	8.40
10-0007-016	ACR reduction sleeve	ø 1.60	8.40
10-0007-018	ACR reduction sleeve	ø 1.80	8.40
10-0007-020	ACR reduction sleeve	ø 2.00	8.40
10-0007-025	ACR reduction sleeve	ø 2.50	8.40
10-0007-000	Complete set of ACR reduction sleeves	ø 0.5 to 2.00	139.00

**QUANTITY DISCOUNT**

0 to 9 parts	net	50 to 99 parts	8%
10 to 49 parts	5%	100 parts and more	10%



ITEM CODE		DIAMETER	PRICE IN CHF
10-0006-005	STD reduction sleeve	∅ 0.50	16.60
10-0006-006	STD reduction sleeve	∅ 0.60	16.60
10-0006-007	STD reduction sleeve	∅ 0.70	16.60
10-0006-008	STD reduction sleeve	∅ 0.80	16.60
10-0006-009	STD reduction sleeve	∅ 0.90	8.40
10-0006-010	STD reduction sleeve	∅ 1.00	8.40
10-0006-011	STD reduction sleeve	∅ 1.10	8.40
10-0006-012	STD reduction sleeve	∅ 1.20	8.40
10-0006-013	STD reduction sleeve	∅ 1.30	8.40
10-0006-014	STD reduction sleeve	∅ 1.40	8.40
10-0006-015	STD reduction sleeve	∅ 1.50	8.40
10-0006-016	STD reduction sleeve	∅ 1.60	8.40
10-0006-018	STD reduction sleeve	∅ 1.80	8.40
10-0006-020	STD reduction sleeve	∅ 2.00	8.40
10-0006-025	STD reduction sleeve	∅ 2.50	8.40
10-0006-000	Complete set of STD reduction sleeves	∅ 0.5 à 2.00	139.00

**QUANTITY DISCOUNT**

0 to 9 parts	net	50 to 99 parts	8%
10 to 49 parts	5%	100 parts and +	10%



ITEM CODE		SCREWDRIVER BITS $\varnothing$	PRICE IN CHF
10-0001-005	STD screwdriver bit for slotted screws	0.50	9.10
10-0001-006	STD screwdriver bit for slotted screws	0.60	9.10
10-0001-007	STD screwdriver bit for slotted screws	0.70	9.10
10-0001-008	STD screwdriver bit for slotted screws	0.80	9.10
10-0001-009	STD screwdriver bit for slotted screws	0.90	9.10
10-0001-010	STD screwdriver bit for slotted screws	1.00	9.10
10-0001-011	STD screwdriver bit for slotted screws	1.10	9.10
10-0001-012	STD screwdriver bit for slotted screws	1.20	9.10
10-0001-013	STD screwdriver bit for slotted screws	1.30	9.10
10-0001-014	STD screwdriver bit for slotted screws	1.40	9.10
10-0001-015	STD screwdriver bit for slotted screws	1.50	9.10
10-0001-016	STD screwdriver bit for slotted screws	1.60	9.10
10-0001-018	STD screwdriver bit for slotted screws	1.80	9.10
10-0001-020	STD screwdriver bit for slotted screws	2.00	9.10
10-0001-025	STD screwdriver bit for slotted screws	2.50	9.10
10-0001-030	STD screwdriver bit for slotted screws	3.00	9.10
10-0001-000	Complete set of STD screwdriver bits	0.5 to 2.00	127.40





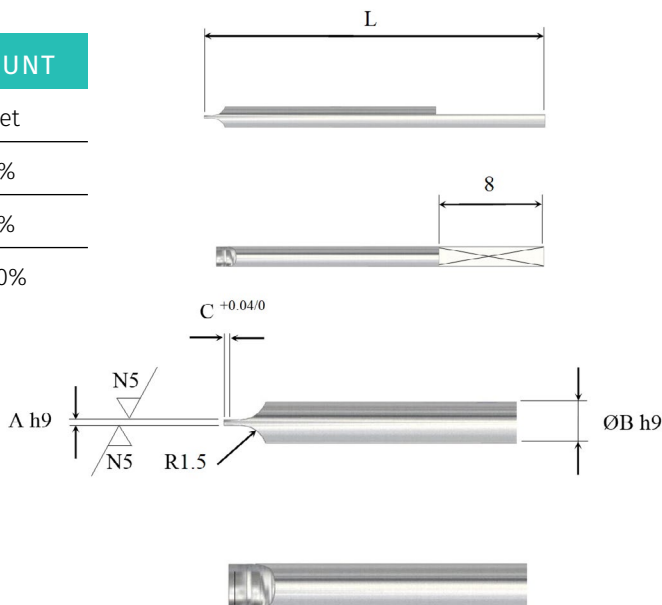



**QUANTITY DISCOUNT**

0 to 9 parts	net
10 parts	3%
20 parts	5%
50 parts	10%



Ah9	$\varnothing B H9$	C $+0.04/0$	L
0.1	0.5	0.15	22
0.12	0.6	0.15	22
0.14	0.7	0.18	22
0.14	0.8	0.18	22
0.14	0.9	0.18	22
0.14	1.0	0.18	22
0.14	1.1	0.18	22
0.14	1.2	0.18	22
0.16	1.3	0.2	29
0.16	1.4	0.2	29
0.16	1.5	0.2	29
0.16	1.6	0.2	29
0.2	1.8	0.25	29
0.2	2.0	0.25	29
0.25	2.5	0.28	29
0.25	3.0	0.28	29

ITEM CODE		MINIMUM QUANTITIES		UNIT PRICE IN CHF
10-0016-001	ACR screwdriver bits locking screw M1.6x2.1	20.00.-		1.10
10-0016-002	STD screwdriver bits locking screw M2x3	20.00.-		0.70
10-0016-003	STD screwdriver bits locking screw M2x5	20.00.-		0.70
10-0016-004	Turret screws TSE-10 to 51	20.00.-		1.10
10-0016-005	Turret screws TSE-1X1	20.00.-		1.10
10-0016-006	STD screwdriver bits locking screw M2x2	20.00.-		1.10
10-0013-001	ACR O-Ring seal	50 parts		0.60
10-0013-003	O-Ring seal	50 parts		0.60

FOR		ITEM CODE		PRICE IN CHF
TSE-20/21/50	«Natural» anodized screwdriver turret	10-0015-001		26.40
TSE-30/31	«Grey» anodized screwdriver turret	10-0015-002		26.40
TSE-10/11/40/41	«Black» anodized screwdriver turret	10-0015-003		26.40
TSE-1X1	«Black» anodized screwdriver turret	10-0015-020		26.40
TR-10/11	«Black» anodized screwdriver turret	10-0017-001		6.80
TR-20/21	«Natural» anodized screwdriver turret	10-0017-002		6.80
TR-30/31	«Grey» anodized screwdriver turret	10-0017-003		6.80
CM-02/05/50/100	«Natural» anodized torque meter turret	10-0014-001		18.70
	Teflon ring	10-0017-004		6.10 or 5.60 from 100 parts