

TYPE		ITEM CODE	PRICE IN CHF
STD 4	STD 4 points measuring instrument	40-0001-020	11'060.00
<p><u>Including :</u></p> <ul style="list-style-type: none"> - 1 4 points measuring device - 1 SYLVAC digital sensor - 4 STD measuring keys $\varnothing 6\text{mm}$ / 0.5mm - 1 STD ring $\varnothing 25$ - 1 STD pad $\varnothing 25$ 			



All our 4 points measuring instruments are supplied in a carrying case with a bottle of rust inhibitor, a brush, bristle sheets, two wrenches, a standard ring $\varnothing 25$ and a standard pad $\varnothing 25$.

FULL DATA SHEET



ACCESSORIES AND AFTER-SALES SUPPLIES	ITEM CODE	PRICE IN CHF
STD Measuring button $\varnothing 6\text{mm}$ / 0.5mm	10-0009-XXX	
STD ring $\varnothing 25$	10-0011-025	
Buffer $\varnothing 25$	10-0012-025	
STD complete capstan	10-0009-004	



OPTIONS	ITEM CODE	PRICE IN CHF
Large-capacity measuring table \varnothing int. 43 to 101mm - \varnothing ext. 32 to 89mm	10-0019-001	
Large-capacity measuring button $\varnothing 6\text{mm}$ / 0.5mm	10-0019-XXX	
Table height control set	10-0019-006	



OPERATING PRINCIPLE

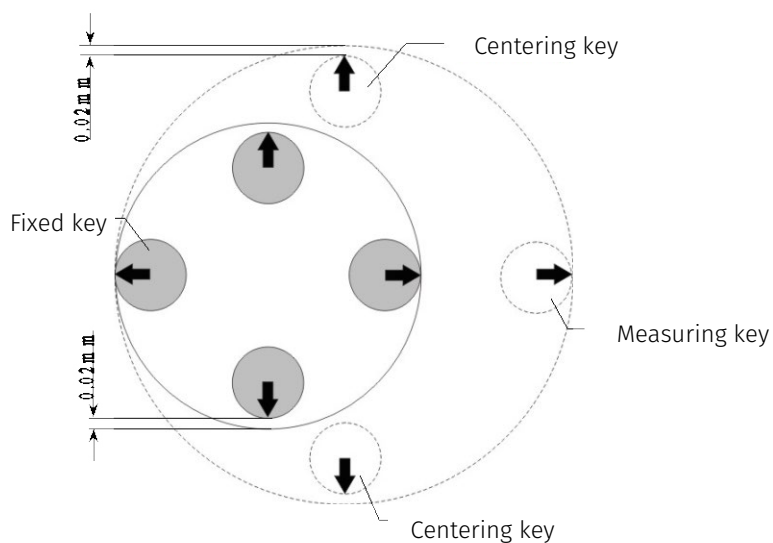

APPLICATION EXAMPLES

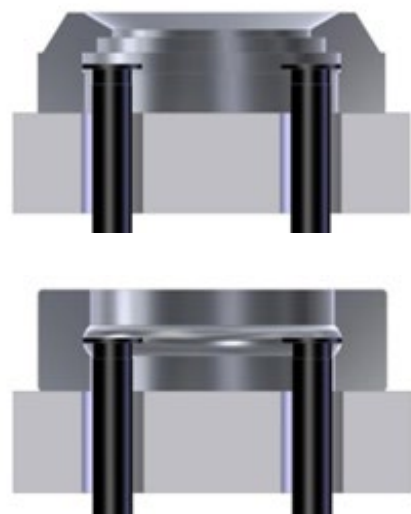



The 4 points is a self-centering internal and external measuring device. Its design rationalizes measurement in both manufacturing and final inspection.

Interchangeable hard-metal keys ensure optimum adaptation to the measurement task. Calibration is performed using a gauge ring or a gauge pad of any size within the measuring stroke. The gauge value must be known to within 1 µm.







4 POINTS DEVICE

Repeatability	± 1 µm
Linearity (10 mm)	± 2 µm
Stroke	30 mm
Measuring force	0.2" - 2.5"
Internal measuring capacity with standard keys	15 – 45 mm
External measuring capacity with standard keys	3 – 33 mm
Internal measuring capacity with special keys and tables	2 – 101 mm
External measuring capacity with special keys and tables	2 – 95 mm
Table height travel	12 mm
Dimensions	350 x 150 x 90 mm
Weight	8 kg

SYLVAC S DIAL PRO BASIC 50 DIGITAL COMPARATOR

Measuring stroke	± 1 µm
Accuracy	± 2 µm
Metric display	30 mm
Inch display	0.2 N – 2.5 N
Digit height	15 – 45 mm
Memory	3 – 33 mm
Tolerance and zeroing input	2 – 101 mm
Data output	2 – 95 mm
Power supply	8 kg



	ITEM CODE		PRICE IN CHF
STD fixed or measuring key $\phi 6\text{mm}$ / 0.5mm (1part)	10-0009-001		198.00
STD right-hand centring key $\phi 6\text{mm}$ / 0.5mm	10-0009-002		198.00
STD left centering key $\phi 6\text{mm}$ / 0.5mm	10-0009-003		198.00
STD keys set (4 parts) $\phi 6/0.5\text{mm}$	10-0009-000		660.00
STD complete capstan	10-0009-004		545.00
Calibration gauge $\phi 25$	10-0011-025		165.60
Calibration buffer $\phi 25$	10-0012-025		165.60

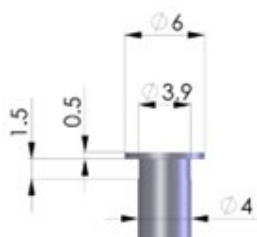

FOR OTHER
DIMENSIONS, PLEASE
CONTACT US!

	ITEM CODE		PRICE IN CHF
Large-capacity measuring table $\varnothing 43$ to $\varnothing 73$	10-0019-001		2'254.00
Large-capacity fixed key $\varnothing 6\text{mm}/0.5\text{mm}$ ($\varnothing 43$ to $\varnothing 73\text{mm}$)	10-0019-002		277.00
Large-capacity measuring key $\varnothing 6\text{mm}/0.5\text{mm}$ ($\varnothing 43$ to $\varnothing 73\text{mm}$)	10-0019-003		277.00
Large-capacity straight centering key $\varnothing 6\text{mm}/0.5\text{mm}$ ($\varnothing 43$ to $\varnothing 73\text{mm}$)	10-0019-004		277.00
Large-capacity left-hand centring key $\varnothing 6\text{mm}/0.5\text{mm}$ ($\varnothing 43$ to $\varnothing 73\text{mm}$)	10-0019-005		277.00
Large-capacity keys set (4 pcs.) $\varnothing 6\text{mm}/0.5\text{mm}$ ($\varnothing 43$ to $\varnothing 73\text{mm}$)	10-0019-000		850.00
Table height control set	10-0019-006		405.00

